

PAMS Technical Documentation

NSM-5 Series Transceivers

Disassembly & Troubleshooting Instructions

CONTENTS

Disassembly of NSM-5	3
Transceiver Troubleshooting	10
Baseband Troubleshooting	10
PCB Test Points	10
Testing	12
Troubleshooting	13
System Clock	14
Sleep Clock	15
Power Supplies	16
Phone is totally dead	19
Flash programming fails	19
Power doesn't stay on or phone is jammed	19
Contact Service on the phone display	19
SIM related faults	21
Audio faults	22
Charging fault	24
RF Troubleshooting	25

Disassembly of NSM-5



NSM-5 phone.



NSM-5 phone disassembled.

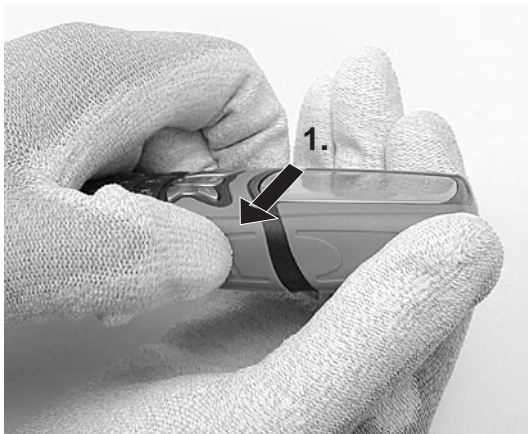

1. Remove the battery.

Step 1. Press the grip markings on both sides of the phone.



Step 2. Slide the top cover (A-shell) off the phone.

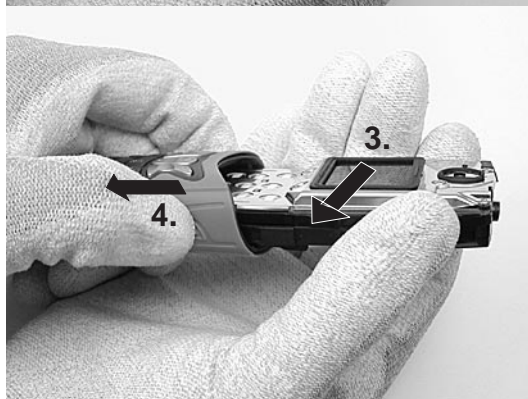

Step 3. Press the release springs on both sides of the frame and 4. slide the bottom cover (B-shell) off the phone.



Step 5. Turn the phone around and remove the battery. Use the recess next to the SIM card holder.

NOTE: SIM card can be removed after the battery removal.

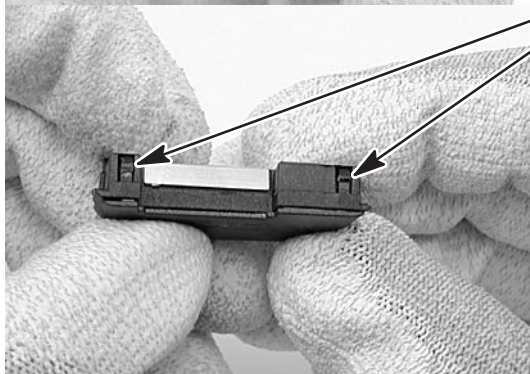
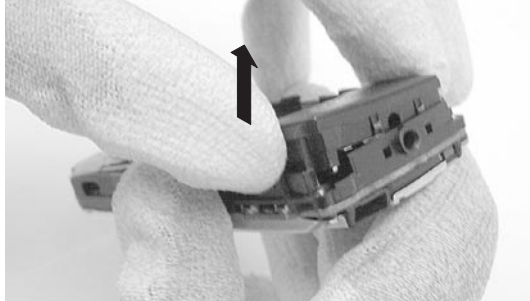
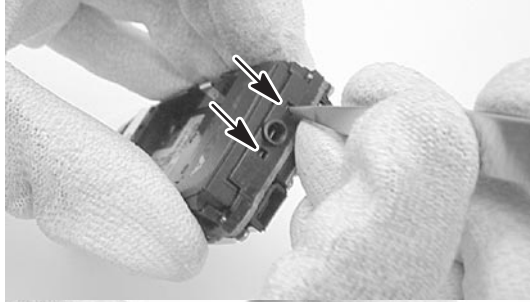
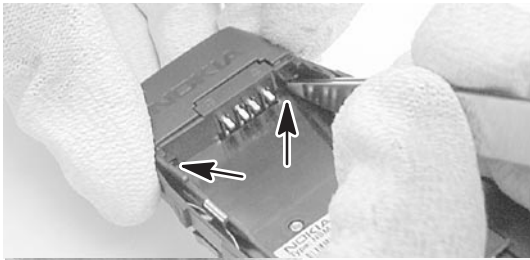

2.

Remove the antenna.

Step 1. Release the snap fixings by pushing slightly from both battery housing corners.

Step 2. Release the snap fixings also from the other end of the antenna.

Step 3. Remove the antenna from the main frame.

Step 4. Visually verify all electrical contact points and that the antenna has not been damaged (note the 4 fixings).

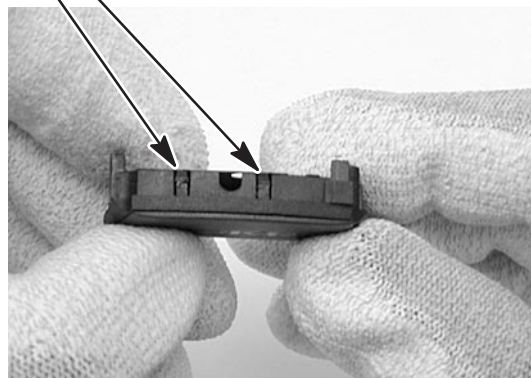

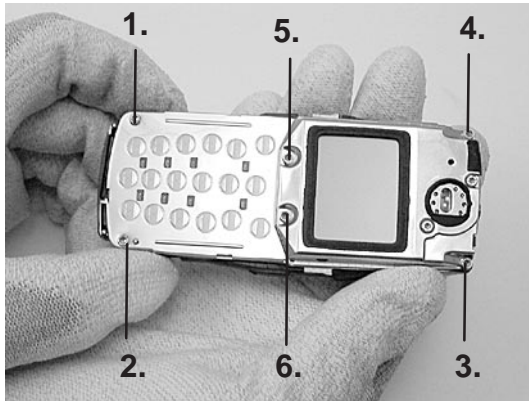

3.

Remove the UI module.

Remove the frame screws (6 pcs) starting from number 1 (bottom left).

NOTE: In assembly use reversed order.

NOTE: When assembling the screws, use 17 Ncm torque.



Drive size is torx plus 6.

Tightening torque is 17 Ncm.

In assembly check that PWB is not bent.



UI module can now be separated from the main frame/system module.



UI module and system PWB apart.

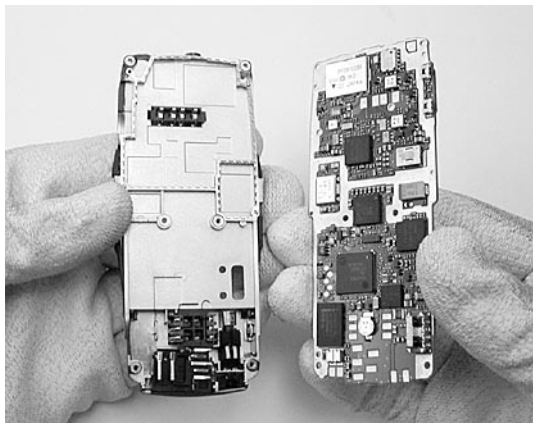

4.

Remove the system PWB from the main frame.

Be careful not to damage the metal gasket.

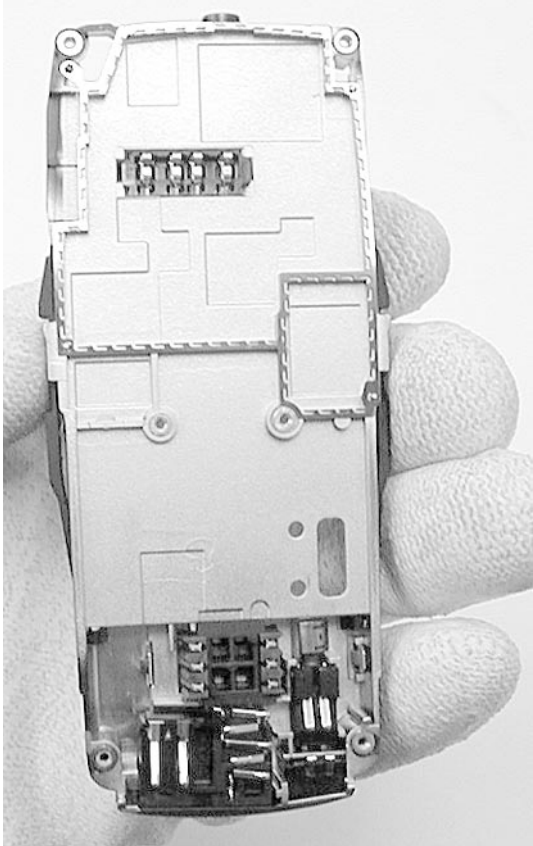

Main frame assembly.

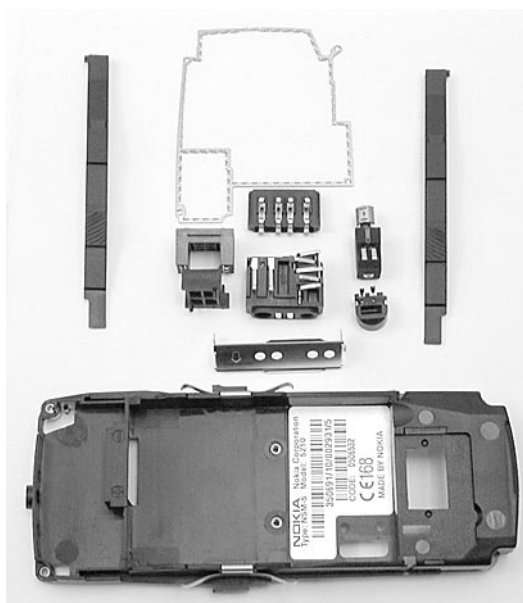

Main frame disassembled.



5. Removing battery connector and SIM spring.

Slide the SRT-3 (Battery Connector Extractor Tool) towards the battery connector and it will be released from the main frame.



To remove the SIM spring from the main frame turn the phone around.

Use appropriate tool to unlock one end of the SIM spring.



Release the other end of SIM spring and the spring will come off.



6.

Speaker and display removal.

Remove UI module screws (2 pcs).

NOTE: When assembling the screws, use 8 Ncm torque.



To remove the display release the snap fixings on both sides of the module.



Speaker can now be removed.

NOTE: Do not damage the speaker contact springs.

Transceiver Troubleshooting

Baseband Troubleshooting

Because of the underfilling of the MAD and combo memory, it is impossible to change those.

PCB Test Points

Reference	Signal	Note
C213	RFC	MAIN CLOCK (13MHz) HAGAR (N505) → MAD (D200)
J100*	PWM	CHARGE CURRENT CONTROL CCONT (N100) → CHAPS (N101)
J101	FBUSTX	FBUS TRANSMITTED DATA MAD (D200) → SERVICE INTERFACE
J102	FBUSRX	FBUS RECEIVED DATA SERVICE INTERFACE → MAD (D200)
J103	MBUS	ONE WIRE TWO DIRECTION SERIAL BUS (9600 BIT/S) MAD (D200) ↔ SERVICE INTERFACE
J104	CCONT CSX	CCONT (N100) CHIP SELECT MAD (D200) → CCONT (N100)
J223	CCONT INT	CCONT (N100) INTERRUPT MAD (D200) → CCONT (N100)
J226	VCXOPWR	26MHz SYSTEM CLOCK CONTROL MAD (D200) → VCXO (G830)
J227	PURX	POWER UP RESET CCONT (N100) → MAD (D200)
J228	SLEEPCLK	SLEEP CLOCK (32kHz) CCONT (N100) → MAD (D200)
J230	GND	GROUND
J234*	HAGAR_RESET_X	HAGAR (N505) RESET MAD (D200) → HAGAR (N505)
J235	ROM1SELX	FLASH CHIP SELECT MAD (D200) → COMBO MEMORY (D210)
J236	RAMSELX	RAM CHIP SELECT MAD (D200) → COMBO MEMORY (D210)
J237	SYNTHDATA (SDATA)	HAGAR (N505) SERIAL DATA MAD (D200) → HAGAR (N505)
J239	DSPXF	NOT CONNECTED
J240	MCURDX	MCU READ MAD (D200) → COMBO MEMORY (D210)
J241	MCUWRX	MCU WRITE MAD (D200) → COMBO MEMORY (D210)
J242	MCUAD1	MCU ADDRESS LINE 1 MAD (D200) → COMBO MEMORY (D210)

Reference	Signal	Note
J245*	SCLK	HAGAR (N505) SERIAL CLOCK MAD (D200) → HAGAR (N505)
J250	COBBA CSX	COBBA (N250) CHIP SELECT MAD (D200) → COBBA (N250)
J251	COBBA SDA	COBBA (N250) SERIAL BUS DATA MAD (D200) ↔ COBBA (N250)
J252	COBBA CLK	COBBA (N250) SERIAL BUS CLOCK MAD (D200) → COBBA (N250)
J253	PCMRXDATA	AUDIO RECEIVED DATA COBBA (N250) → MAD (D200)
J254	PCMDCLK	AUDIO DATA CLOCK (512KHz) MAD (D200) → COBBA (N250)
J255	PCMSCLK	AUDIO SYNC CLOCK (8kHz) MAD (D200) → COBBA (N250)
J255	ESYSRESETX	COMPOMEMORY (D210) ENABLE MAD (D200) → COMBO MEMORY (D210)
J256	PCMTXDATA	AUDIO TRANSMITTED DATA MAD (D200) → COBBA (N250)
J257	CCUT (MCUGENIO0)	CHARGE CUT MAD (D200) → CHAPS (N101)
J258*	BUTTON_CTRL (MCUGENIO1)	HEADSET BUTTON DETECTION CONTROL MAD (D200) → XMICP
J259	MCUGENIO2	NOT CONNECTED
J260	EXTMCUDA0	MCU DATA LINE 0 MAD (D200) ↔ COMPOMEMORY (D210)
J299*	TXP	TRANSMITTER POWER CONTROL MAD (D200) → RF
L200	MIC	MIC BIAS VOLTAGE, 2.1V IF NO MIC V250 → MIC
N310 PIN 13	KBD LIGHT	KEYPAD LED LIGHT CURRENT UI-SWITCH (N310) → KEYPAD BACKLIGHT LEDS
N310 PIN 14	KBDLED_ADJ	KEYPAD BACKLIGHT BRIGHTNESS ADJUSTMENT R311 → UI-SWITCH (N310)
N310 PIN 16	VIBRA_CTRL	VIBRA DRIVE UI-SWITCH (N310) → VIBRA (M300)
N310 PIN 19	VIBRA	VIBRA CONTROL PWM MAD (D200) → UI-SWITCH (N310)
N310 PIN 3	BUZZER	BUZZER CONTROL PWM MAD (D200) → UI-SWITCH (N310)
N310 PIN 6	BUZZER_CTRL	BUZZER DRIVE UI-SWITCH (N310) → BUZZER (B301)
N310 PIN 7	KBLIGHTS	KEYPAD AND DISPLAY BACKLIGHT CONTROL MAD (D200) → UI-SWITCH (N310)

Reference	Signal	Note
N310 PIN 8	LCDLED_ADJ	LCD BACKLIGHT BRIGHTNESS ADJUSTMENT R310 -> UI-SWITCH (N310)
N310 PIN 9	LCD LIGHT	LCD LED LIGHT CURRENT UI-SWITCH (N310) -> DISPLAY BACKLIGHT LEDES
N400 PIN 4	IRONX	IRDA (N400) SHUTDOWN MAD (D200) -> IRDA (N400)
N401 PIN 4	IRDA POWER	2.8V N401 -> IRDA (N400)
R118	PWRONX	POWER ON BUTTON POWER BUTTON (S330) -> CCONT (N100)
R206	SENA	HAGAR (N505) CHIP SELECT MAD (D200) -> HAGAR (N505)
R211	VPP	FLASH PROGRAMMING VOLTAGE N220 -> COMPOMEMORY (D210)
R277	EAD	ACCESSORY DETECTION XMICP -> CCONT (N100)

*Only in NSM-5..

Testing

The MCU software enters a local mode at start-up if suitable resistors are connected to the BTEMP and BSI lines.

NOTE! Baseband doesn't wake up automatically when the battery voltage is connected. Power must be switched on by

- pressing the Power key or
- inserting a waking pulse BTEMP line or
- connecting a charger

In the local mode the baseband can be controlled through MBUS or FBUS connections by a PC-locals software. Baseband internal connections are tested with selftests if possible.

Parameters cannot be set accurate enough by design because of component tolerances. Due to use of 5% resistor values, the channels of the CCONT A/D converters need to be aligned in the production phase. Within battery voltage tuning the MCU software reads the A/D reading from CCONT at 4.1V and stores this reading to emulated EEPROM memory as a reference point. Another reference point is created by assuming that while the input voltage is zero, A/D reading is also zero. Now the slope is known and A/D readings can be calibrated. Calibration is included in VBATT A/D reading task.

Troubleshooting

Troubleshooting instructions are divided into following sections:

- How to check/fix the system/sleep clock.
- How to check/fix the power supplies.
- Contact service case.
- How to check/fix the SIM faults.
- How to check/fix the Audio faults.
- How to check/fix the charger faults.

The first thing to do is to carry out a thorough visual check of the module.
Make sure that:

- there are no mechanical damages
- solder joints are OK

Before changing anything ALL SUPPLY VOLTAGES AND SYSTEM CLOCK / SLEEP CLOCK should be checked.

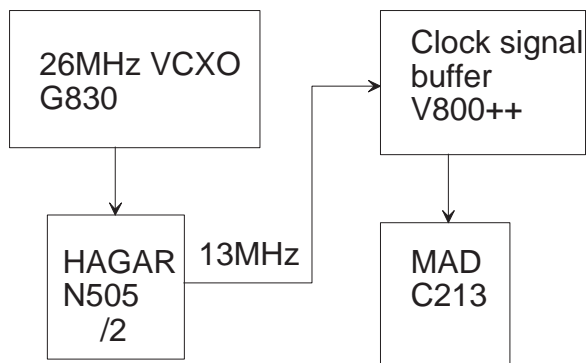

System Clock

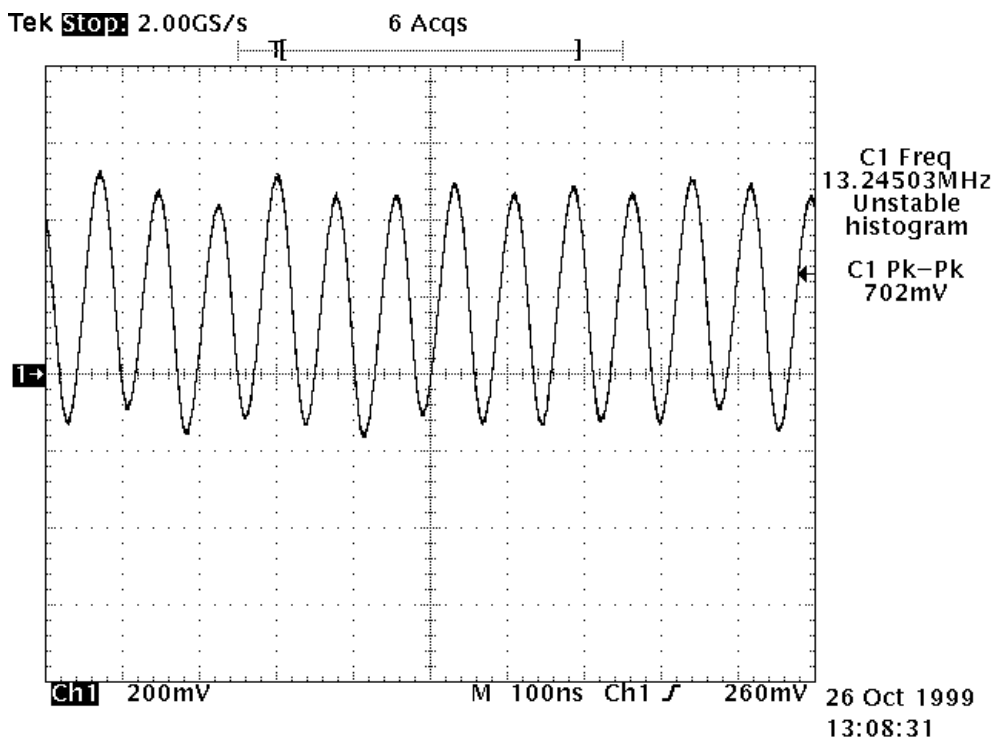
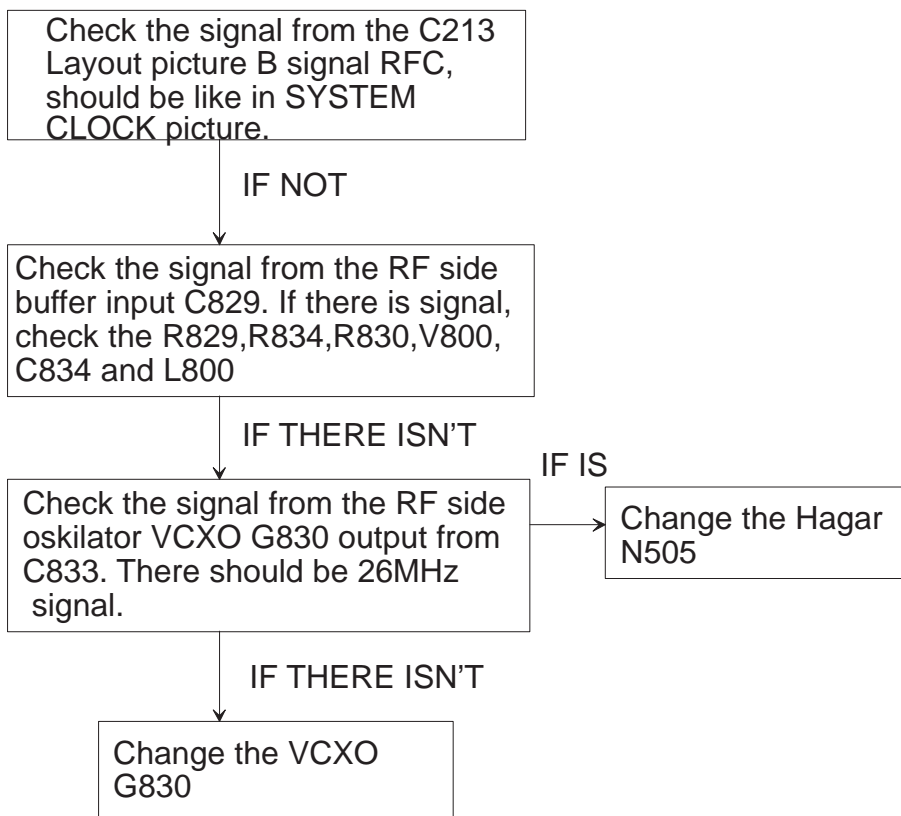

System clock picture.

Sleep Clock

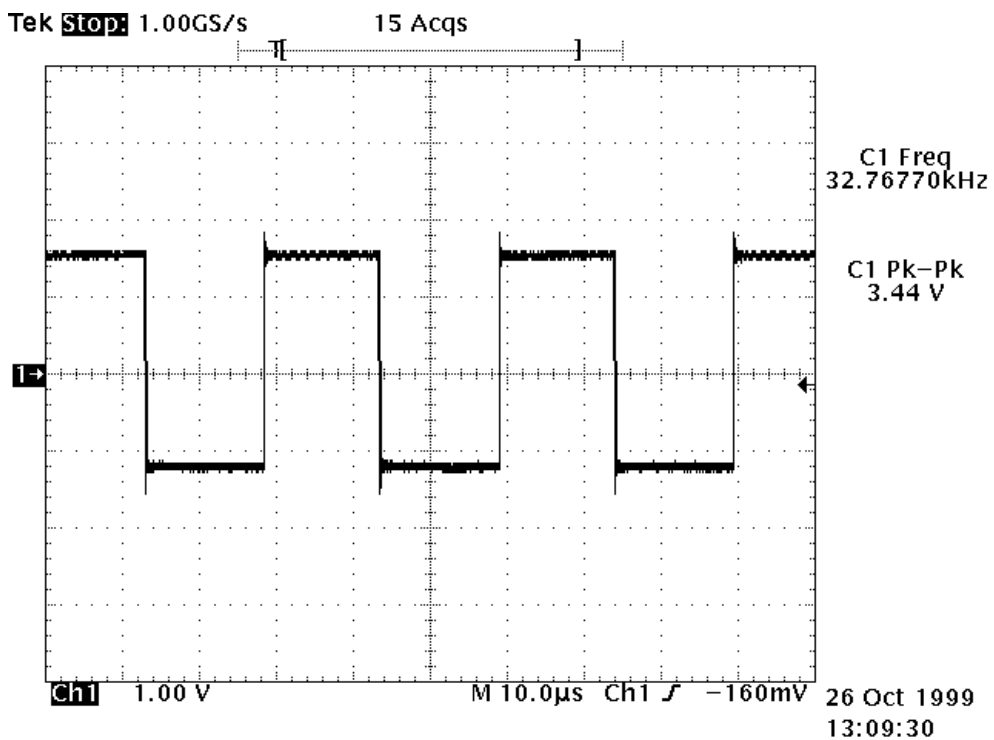
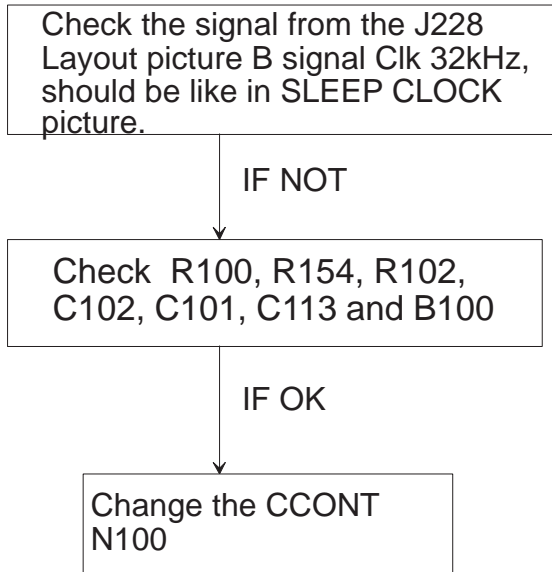

Sleep clock picture.

Vbb	= 2.7V – 2.87V
Vcore	= 1.3V – 2.65V
Vcobba	= 2,67V – 2.85V
Vref	= 1.48V – 1.523V
Vbat	= 3.11V – 4.2V
VXO	= 2,67V – 2.85V
VRX	= 2,67V – 2.85V
VTX	= 2,67V – 2.85V
Vsyn1	= 2,67V – 2.85V
Vsyn2	= 2,67V – 2.85V

Power up sequence test:

Cconts digital parts keep MAD in reset by keeping PURX down for a delay of 62ms.

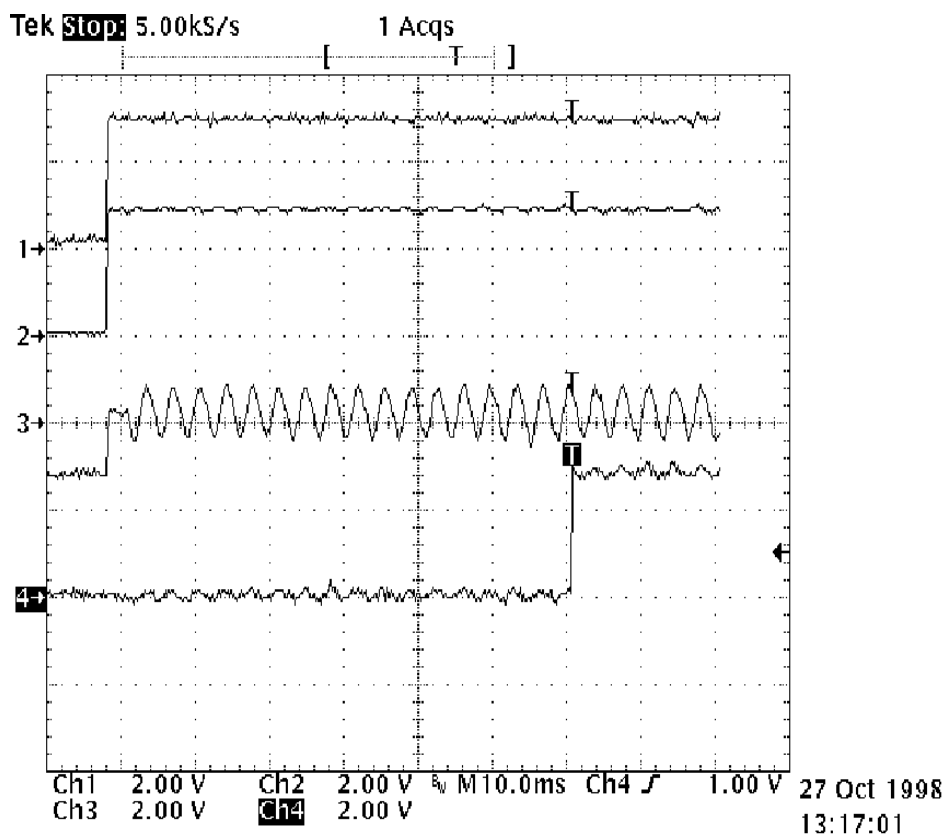

Here is shown the start up sequence picture.

- Ch1 = Vbb
- Ch2 = VXO
- Ch3 = SleepClk
- Ch4 = PURX (see picture B)

B

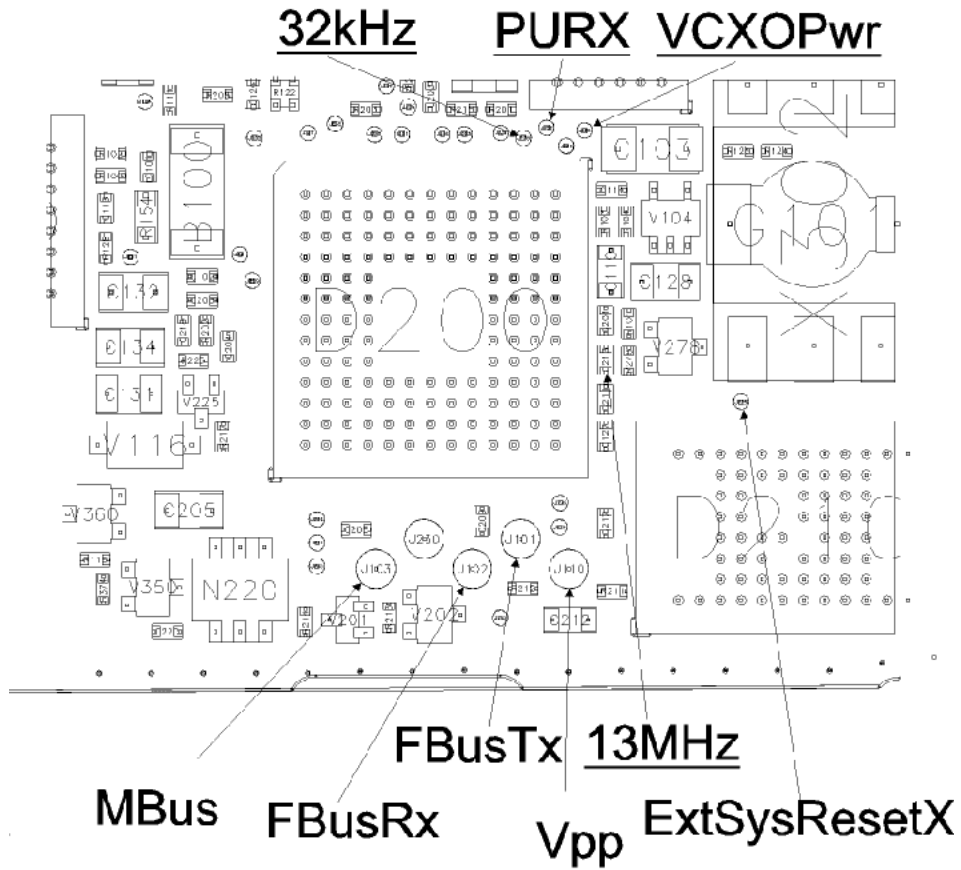

Phone is totally dead

The phone doesn't take current at all when the power switch is pressed or when the watchdog disable pin (X001 pin 11) is grounded. Make sure that the battery voltage you use is within the specification, i.e. 3.11 .. 4.2 V. If the voltage is lower, hardware of CCONT (N100) prevents power on.

IF battery voltage is inside the specification Change the CCONT.

Flash programming fails

The flash programming can be done via panel connector X001 or via dedicated PCB pads. In production, the first programming is done via panel connector. After this, the panel connector is cut away, thus the programming must be done via PCB pads visible through the shield under the battery. The main difference between these is that FLASH-programming voltage is produced differently. The fault finding diagrams for flash programming is shown in the start up sequence picture.

In flash programming error cases the flash prommer can give some information about a fault. The fault information messages could be:

- MCU doesn't boot
- Serial clock line failure
- Serial data line failure
- External RAM fault
- Algorithm file or alias ID not found
- MCU flash Vpp error

Power doesn't stay on or phone is jammed

If this kind of fault has come after flash programming, there are most probably open joints in ICs. Solder the joints of ICs. Normally the power will be switched off by CCONT (N100) after 30 seconds if the watchdog of the CCONT can not be served by software. This updating can be seen with an oscilloscope at CCONTCSX (J104). In normal case there is a short pulse from "1" to "0" every 8 seconds. The power off function can be prevented by connecting WDDIS (R118 edge side head) to ground.

Because of the underfill, check the supply voltages, clock signals and power up sequence. If power on sequence fails, there are some open connections under MAD or compomemory. If all seems to be correct, it is best way to erase the flash memory and try to put new software to phone.

Contact Service on the phone display

This fault means that software is able to run and thus the watchdog of CCONT (N100) can be served. Selftest functions are run when power is switched on and software is executed from flash. If any of the selftests fails, a "contact service" text is shown on display.

MCU self tests are divided to those executed while power up (start up tests) and ones that can be executed with connected PC. The tests and included items are as follows:

1. MCU ROM checksum

Calculates 16 bit checksum out of Flash code and compares it to one found in Flash.

Items being checked are:

MAD2 <—> Flash data and address lines, CE0,CE1, WE, BYTE, Vcc, GND, Flash internal functionality

2. MCU RAM interface

3. MCU RAM component

4. MCU EEPROM interface

5. MCU EEPROM component

6. RTC battery

7. CCONT interface

8. A/D converter

9. SW reset

A. Power off

B. Security data

C. EEPROM tune checksum

D. PPM checksum

E MCU download DSP

F. DSP alive

G. COBBA serial

H COBBA parallel

I. EEPROM checksum

K. PPM validity

SIM related faults

The hardware of the SIM interface from MAD2 (D200) to the SIM connector (X302) can be tested without a SIM card. When the power is switched on and the BSI line is grounded by a resistor, all the used lines (VSIM, RST, CLK, DATA) rise up to 5 V four times. Thus “Insert SIM card” faults can be found without SIM card.

The fault information “Card rejected” indicates that ATR message (the first message is always sent from card to the phone) is sent from card but the message is somehow corrupted, data signal levels are wrong etc. or factory set values (stored to the emulated EEPROM) are not correct.

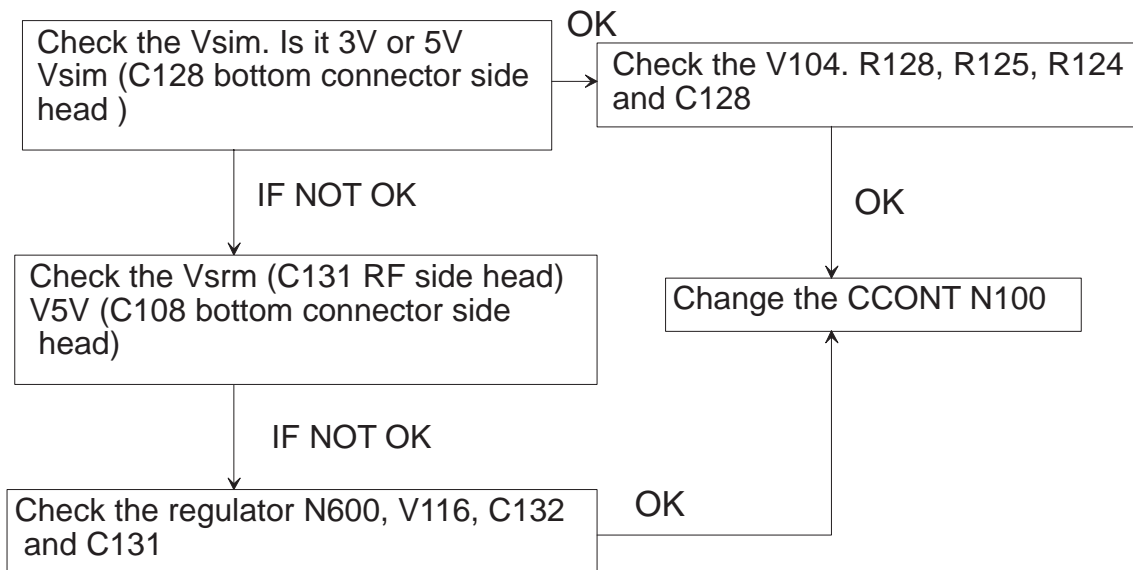

Audio faults

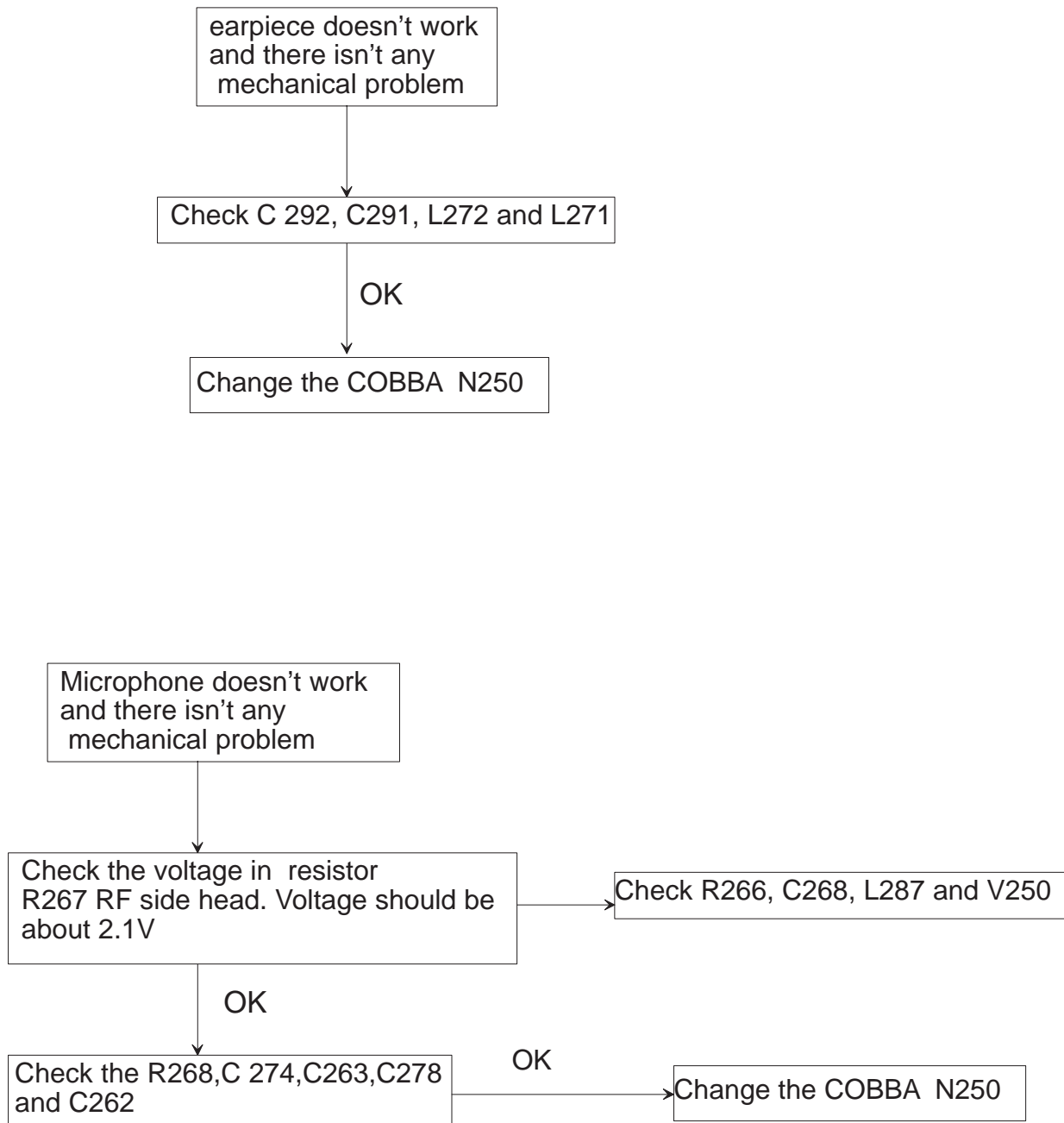

Headset earpiece doesn't work and there isn't any mechanical problem

Check R 257, R256, R270, L284, L283
C284, C283, C 296, C 297, C261 and C255

OK

Change the COBBA N250

Headset earphone doesn't work and there isn't any mechanical problem

Check R 257, R256, R270, L284, L283
C284, C283, C 296, C 297, C261 and C255

OK

Change the COBBA N250

Charging fault

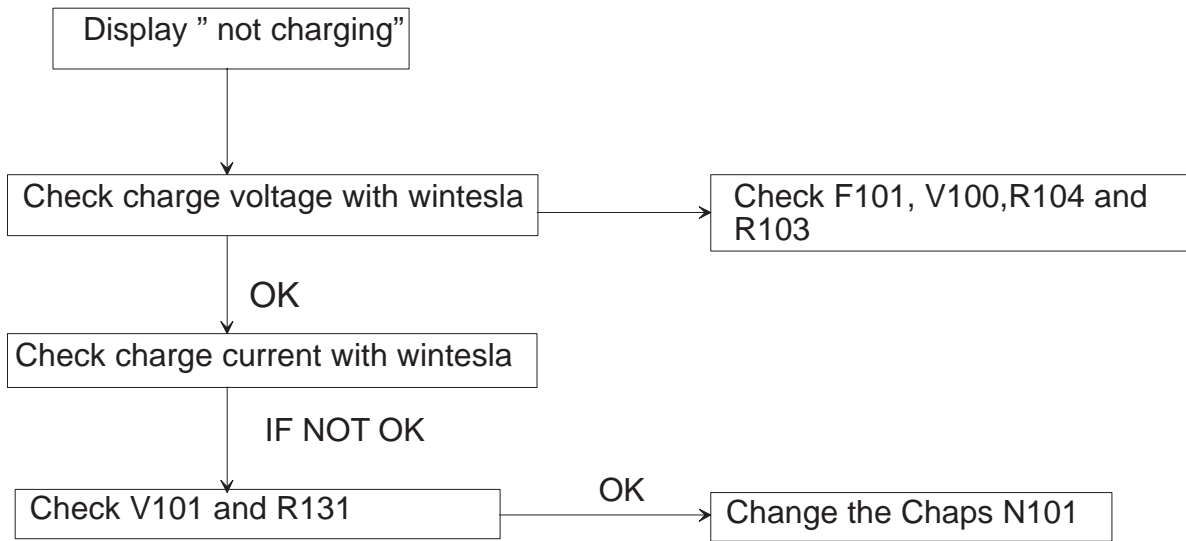

RF Troubleshooting

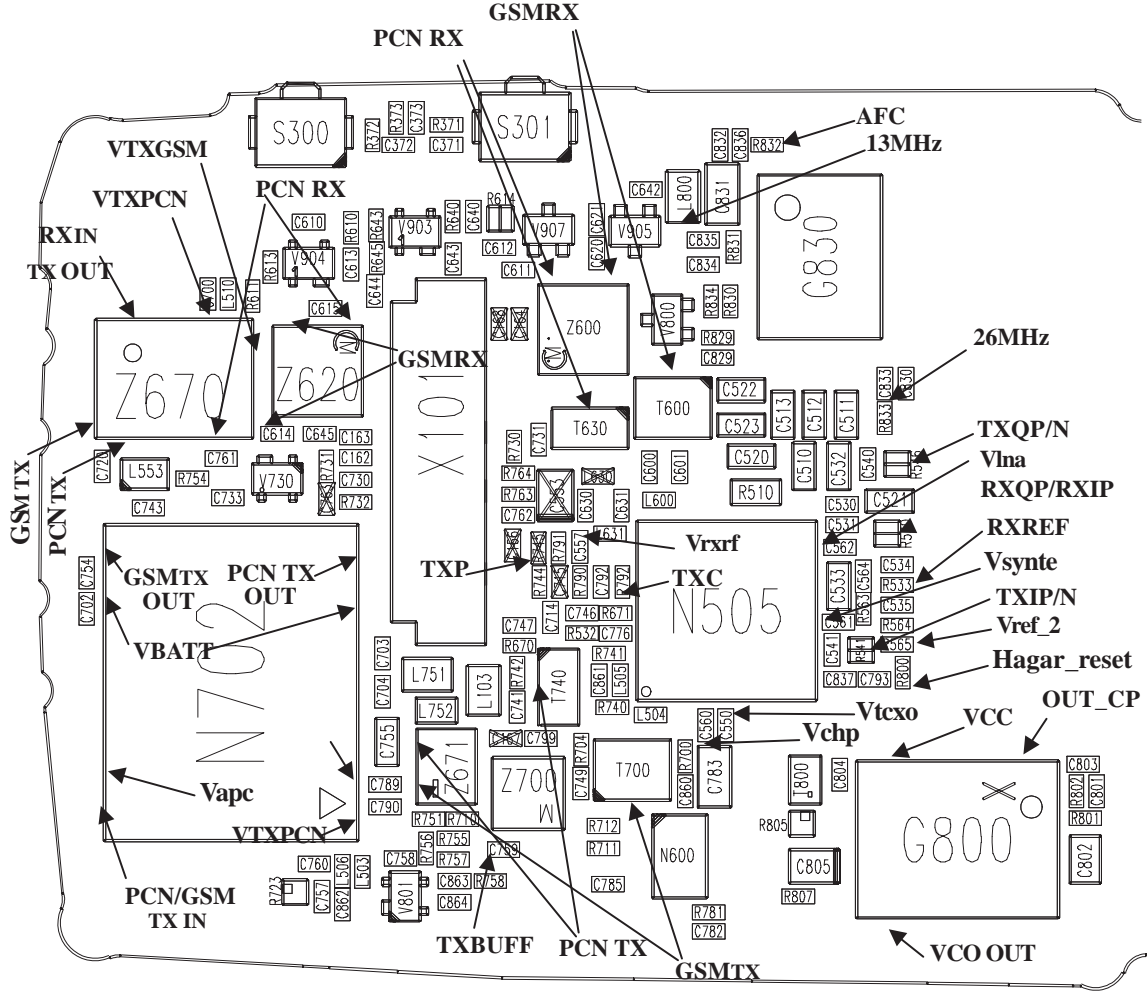

- N702 Poweramplifier
- Z670 Antenna switch
- Z620 First RXSAW
- Z600 SecondRXSAW
- G830 VCTCXQ(26MHz)
- N505 Hagar RF IC
- G800 VCO(3.6GHz)
- Z700 GSM TX SAW
- T600 GSM RX Balun
- T630 PCN RX Balun
- T740 PCN TX Balun
- T700 GSM TX Balun
- T800 VCO Balun (3.6GHz)
- V903 PCN LNA
- V904 GSM LNA
- L553 Dual coupler
- V730 Power detector
- V800 VCTCXO Buffer
- N600 Vcp regulator

This page intentionally left blank.